

RM5766HD

5" Smart High-Definition  
Pan & Tilt Monitor



vtech®

Quick start guide

## WHAT'S IN THE BOX

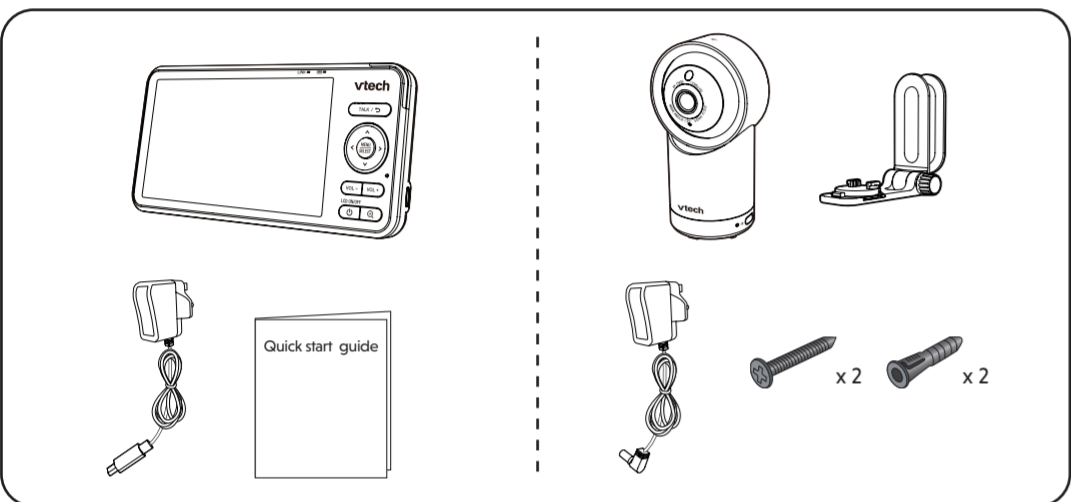

## IMPORTANT SAFETY INSTRUCTIONS

The applied nameplate is located at the bottom of the baby unit base. When in use, basic safety precautions should always be followed to reduce the risk of fire, electric shock and injury, including the following:

- Follow all warnings and instructions marked on the product.
- Adult setup is required.
- CAUTION:** Do not install the baby unit at a height above 2 metres.
- This product is intended as an aid. It is not a substitute for responsible and proper adult supervision and should not be used as such.
- This product is not intended for use as a medical monitor.
- Do not use this product near water, for example, near to a bath, sink, swimming pool or shower.
- CAUTION:** Use only the internally, non-user replaceable battery fitted to the parent unit. There may be a risk of explosion if a wrong type of battery is used for the parent unit. The battery cannot be subjected to high or low extreme temperature and low air pressure at high altitude during use, storage or transportation. Disposal of batteries in fire or a hot oven, mechanically crushing or cutting the battery can result in an explosion. Subjecting products or batteries to an extremely high temperature environment can result in explosion or leakage of flammable liquids, or gas. Products or batteries subjected to extremely low air pressures may result in explosion or leakage of flammable liquids, or gas.

8. Use only the power adaptors supplied with this product. Incorrect power adaptor polarity or voltage can seriously damage the product.

**Power adaptor information:**  
Parent unit output: 5V DC 2A  
Vtech Telecommunications Ltd.  
Model: VT07EUK0520 -OR-  
Jiangxi Jian Aohai Technology Co., Ltd.  
Model: A938-050200W-UK1  
Baby unit output: 5V DC 1.5A  
Vtech Telecommunications Ltd.  
Model: VT07EUK05150 -OR-  
Jiangxi Jian Aohai Technology Co., Ltd.  
Model: A938-050150W-UK1

**Rechargeable battery information:**  
3.7V 3000mAh, 18.5Wh Lithium-ion battery  
Zhuhai Great Power Energy Co., Ltd.  
Model: GSP806090-5Ah-3.7V-151P

- The power adaptor is intended to be correctly oriented in a vertical or floor mount position. The prongs are not designed to hold the plug in place if it is plugged into a ceiling, under-the-table or cabinet outlet.
- For pluggable equipment, the socket-outlet (power adaptor) should be installed near the equipment and should be easily accessible.
- Unplug this product from the wall outlet before cleaning. Do not use liquid or aerosol cleaners. Use a damp cloth for cleaning.
- Do not modify the power adaptors or replace with other third-party adaptors.
- Do not allow anything to rest on the power cords. Do not install this product where the cords may be walked on or damaged.
- The product should only be operated from a power source indicated on the power adaptor label or marking. If you are unsure of the type of power supply in your home, consult your dealer or electricity supply provider.
- Do not overload wall outlets or use an extension cord.
- Do not place this product on an unstable table, shelf, stand or other unstable surfaces.
- This product should not be placed in any area where proper ventilation is not provided. Any slots or openings in the back or bottom of this product are provided for ventilation. To protect from overheating, openings must not be blocked by placing the product on a soft surface such as a bed, sofa or rug. This product should never be placed near or over a radiator or heat source.
- Never insert any objects through any apertures or slots in the product as this can be dangerous and cause damage to the battery or other internal parts. Never spill any liquids on the product.
- To reduce the risk of electric shock, do not disassemble this product, but take it to an authorised service facility. Disassembling or removing parts of the product other than battery replacement via a battery door (if applicable) may expose dangerous voltages or other risks.
- You should test the sound reception every time you turn on the units or move one of the components.
- Periodically examine all components for damage.
- There is a very low risk of privacy loss when using certain electronic devices, such as baby monitors, cordless telephones, etc. To

protect your privacy, make sure the product has never been used before purchase, reset the baby monitor periodically by powering off and then powering on the units, and power off the baby monitor if you are not intending to use it for some time.

- Children should be supervised to ensure that they do not play with the product.
- The small parts of this monitor can be swallowed by babies or small children. Keep these parts out of reach of children.
- The product is not intended for use by persons (including children) with reduced physical, sensory or mental capabilities, or lack of experience and knowledge, unless they have been given supervision or instruction concerning use of the appliance by a person responsible for their safety.

### SAVE THESE INSTRUCTIONS

- Use and store the product at a temperature between 0°C and 40°C.
- Mishandling batteries can cause burn, fire or explosion hazards.
- Batteries should not be exposed to excessive heat such as bright sunshine or fire.
- Do not expose the product to extreme cold, heat or direct sunlight. Do not place the product close to a heating source.
- Warning—Strangulation Hazard—Children have STRANGLED in cords. Keep this cord out of the reach of children (more than 0.9m away). Do not remove warning label on the adaptor cord.**
- Never place the baby unit inside the baby's cot or playpen. Never cover the baby unit or parent unit with anything such as a towel or a blanket.
- Other electronic products can cause interference to your parent unit and baby unit. Try installing your baby unit as far away as possible from the following electronic devices: wireless routers, radios, mobile telephones, intercoms, room monitors, televisions, personal computers, kitchen appliances (e.g. microwave ovens) and cordless telephones.

## STATEMENT OF COMPLIANCE

### Product Security and Telecommunications Infrastructure Regulations

I, Michael Tsui, on behalf of Vtech Telecommunications Limited, hereby declare the following with regards to our products and their compliance with The Product Security and Telecommunications Infrastructure (Security Requirements for Relevant Connectable Products) Regulations 2023 in the United Kingdom.

**Product Information:**  
Product name: 5" Smart High-Definition Pan & Tilt Monitor  
Product Model: RM5766HD  
Product Description: Baby monitor  
Defined support period: Minimum of four years from date of purchase.

The above-mentioned product has been designed, developed, and manufactured in accordance with the applicable security requirements in Schedule 1, prescribed in The Product Security and Telecommunications Infrastructure (Security Requirements for Relevant Connectable Products) Regulations 2023.

This Statement of Compliance is made in good faith, based on the information available to us at the time of issue.

Yours sincerely,

*Michael Tsui*

Michael Tsui  
Approval Supervisor  
Vtech Telecommunications Limited  
23/F, Tai Ping Industrial Centre, Block 1,  
57 Ting Kok Road, Tai Po,  
Hong Kong  
Date: 5th January 2024

## CONNECT, CHARGE AND POWER ON THE BABY MONITOR

- Connect the parent unit and baby unit to the adaptor and mains supply. The parent unit turns on automatically after connection to the power socket.

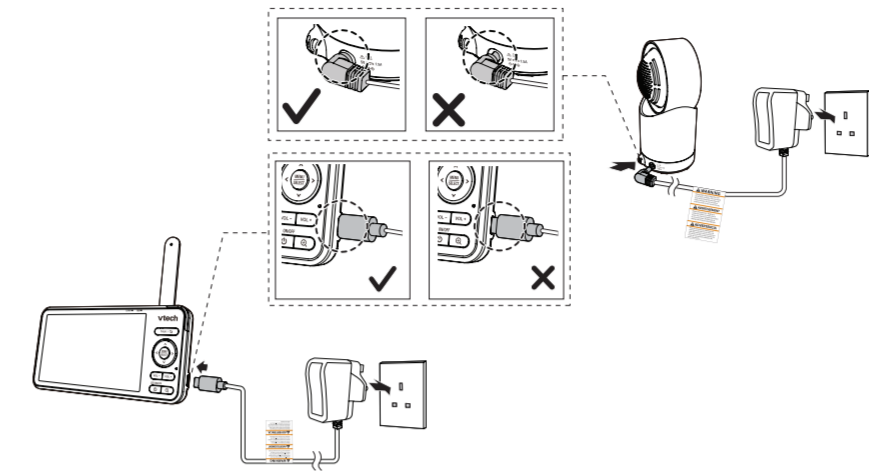

- Slide the switch to **ON** to power on the baby unit.

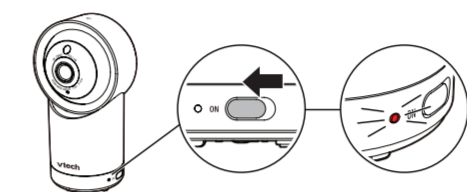

- For optimum reception, always raise the parent unit antenna.

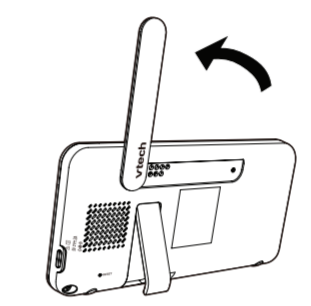

### NOTES

- Peel off the lens/screen protector before use.
- Charge the parent unit battery before use.
- When powering up, the baby unit's orange status LED turns on. It will turn off after a while and remain off if the status LED is set to off.
- The status LED is set to off by default. You can turn it on using the app (Setting > Camera Setting > LED status).
- A steady orange light with no video or audio streaming can indicate a fault condition.
- The baby unit may get warm during use. This is normal.



## DOWNLOAD APP FOR MOBILE ACCESS

Use the **MyVtech Baby Plus** on your mobile device to monitor your baby remotely. Follow the instructions below to set up and pair your baby monitor with the app.



- Scan the QR code to download the free **MyVtech Baby Plus** mobile app, or search "MyVtech Baby Plus" on App Store or Google Play Store. Ensure you have the right app with the purple icon downloaded. If you have previously installed the app, ensure that you have the latest version.



### NOTE

- Make sure your mobile device meets the minimum requirement for the mobile app.

### Minimum requirement

- The mobile app is compatible with:
  - Android™ 9.0 or later (Not compatible with mobile devices with a 32-bit Android operating system); and
  - iOS 14 or later.



- Tap **+** to launch the mobile app on your device and create an account. Note that existing accounts in **MyVtech Baby Pro** cannot sign in to the **MyVtech Baby Plus** app.
- We recommend that you use common webmail services, such as Google Gmail, to register your user account. Check your email (including the Spam folder) and activate your new account by entering the email verification code. Then, sign in to your account.
- Ensure that you are connected to a **2.4GHz Wi-Fi network** and have enabled **Bluetooth** and **Location Service** on your device.
- After signing in to the app, select **Camera(s) with Parent unit** and scan the QR code displayed on the parent unit. To find the QR code, press the **MENU/SELECT** button and go to **Settings > Connect to Mobile App**.
- Input the Wi-Fi password from the app.
- Press and hold the pair key on the baby unit for 3 seconds until you hear the beep sound to enter pairing mode.
- Select the camera model that appears in the app and wait for the camera to connect. Once connected, it will display a live view preview.
- Select "**Continue**" and create a profile for your baby (Optional). Now you can start monitoring!

### TIP

Use **Camera Sharing** to instantly share access to the camera. Follow these steps:

- Go to **Menu** and select **Camera Sharing**.
- Choose "**Invite People**" and enter the name and email address of the family member's app account.
- The family member will receive a pop-up notification in the app and can accept the invitation to access the camera(s).

## OVERVIEW

### Baby unit overview

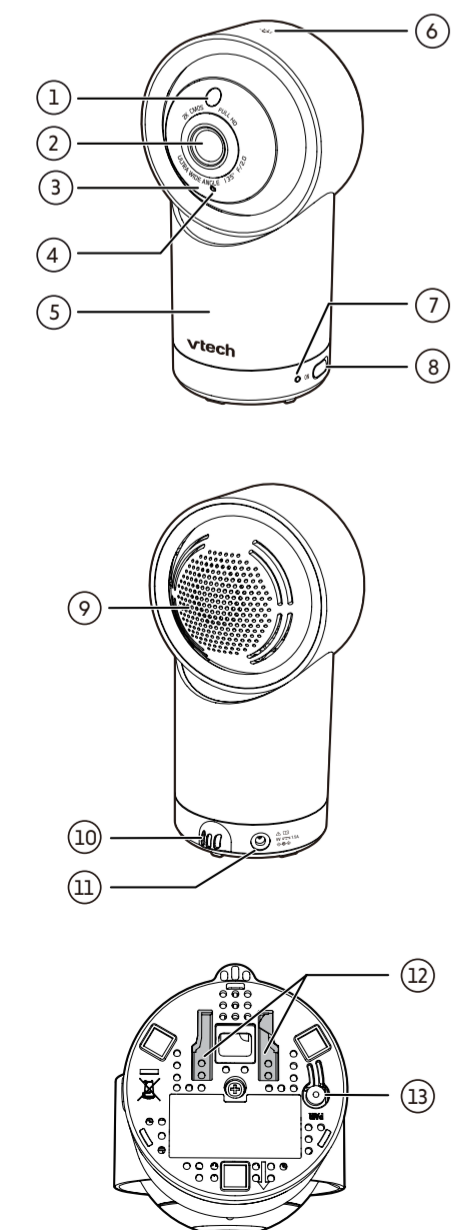

- Light sensor**
- Camera lens**
- Infrared LEDs**
  - Allow you to see clearly in a dark environment.
- Microphone**
- Night Light**
- Night Light Control Key**
  - Single Tap: Turn on/off.
  - Tap and hold (with the light turned on): Adjust night light brightness.
- LED indicator**
  - Set to off by default. You can turn it on using the app (Setting > Camera Setting > LED status).
  - In direct mode:
    - Orange is steadily on when the baby unit is connecting to the parent unit.
    - Orange flashes slowly during video streaming.
  - In Wi-Fi mode:
    - Green is steadily on when the baby unit is connected to Wi-Fi.
    - Green flashes slowly during video streaming to Wi-Fi.
- ON/OFF switch**
- Speaker**
- Temperature sensor**
- Power jack**
- Wall mount slots**
- PAIR**
  - To enter pairing mode, press and hold the **PAIR** key for three seconds until you hear a beep sound. Then follow the app instructions to connect the camera to a 2.4GHz Wi-Fi network.
  - To reset the baby unit, press and hold the **PAIR** key until you hear a beep sound. Release the **PAIR** key, then short press the **PAIR** key five more times until you hear another beep sound. The baby unit will emit one final beep when the reset is complete. After the beep sound, the baby unit will reboot itself.

### Parent unit overview

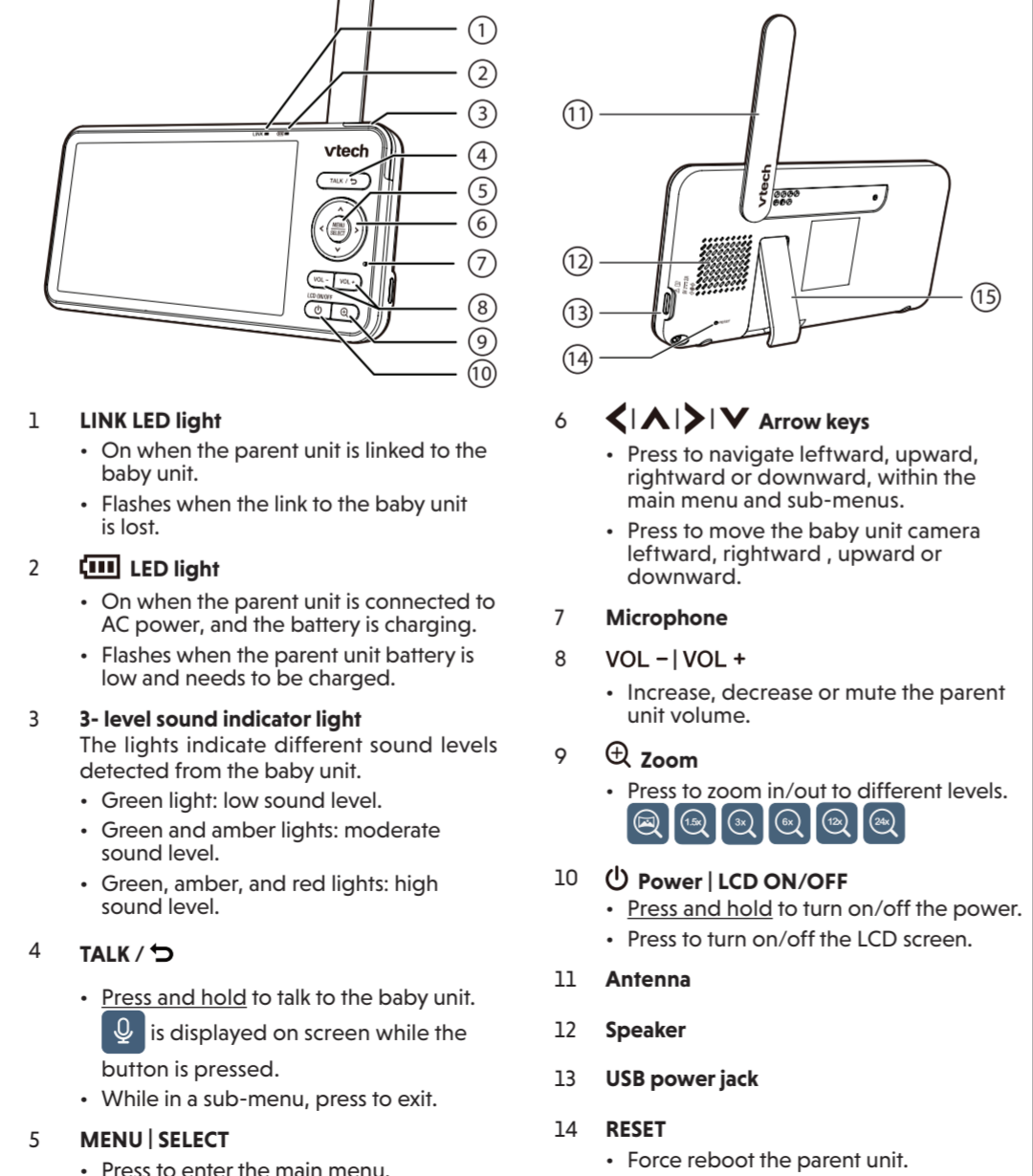

- LINK LED light**
  - On when the parent unit is linked to the baby unit.
  - Flashes when the link to the baby unit is lost.
- LED light**
  - On when the parent unit is connected to AC power, and the battery is charging.
  - Flashes when the parent unit battery is low and needs to be charged.
- 3-level sound indicator light**
  - The lights indicate different sound levels detected from the baby unit.
  - Green light: low sound level.
  - Green and amber lights: moderate sound level.
  - Green, amber, and red lights: high sound level.
- TALK /**
  - Press and hold to talk to the baby unit.
  - is displayed on screen while the button is pressed.
  - While in a sub-menu, press to exit.
- MENU | SELECT**
  - Press to enter the main menu.
  - While in a menu, press to confirm a selection, or save a setting.

## HOW THE SYSTEM WORKS

**TIP** To receive product firmware updates, this baby monitor requires connecting to a **2.4GHz home Wi-Fi network**.

### Direct mode

Your baby monitor parent unit and baby unit connect to each other in **Direct mode** by default, which allows you to immediately stream video out of the box.

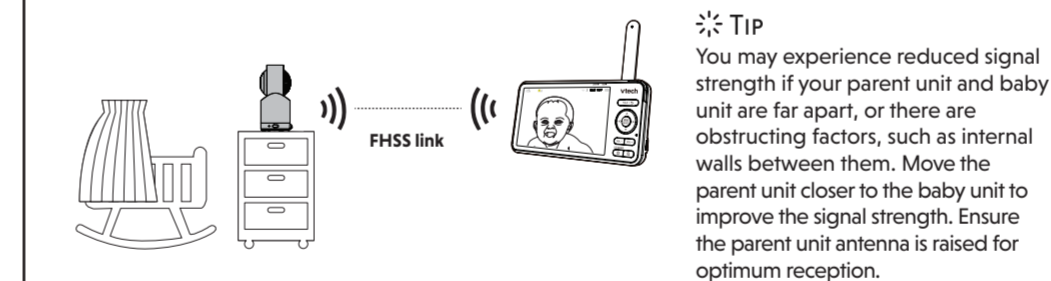

**TIP**  
You may experience reduced signal strength if your parent unit and baby unit are far apart, or there are obstructing factors, such as internal walls between them. Move the parent unit closer to the baby unit to improve the signal strength. Ensure the parent unit antenna is raised for optimum reception.

### Wi-Fi mode

To enhance your experience and enjoy seamless live video streaming via your mobile app, and to receive product software updates (when available), we highly recommend setting up your monitor's Wi-Fi connection.

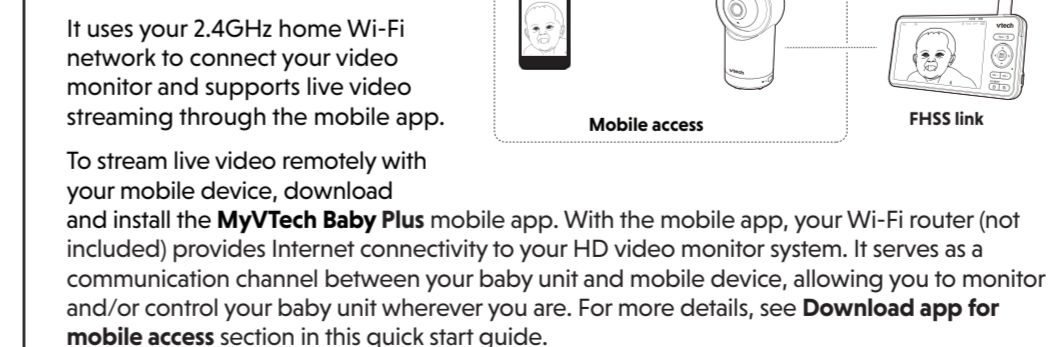

It uses your 2.4GHz home Wi-Fi network to connect your live video monitor and supports live video streaming through the mobile app.

To stream live video remotely with your mobile device, download and install the **MyVtech Baby Plus** mobile app. With the mobile app, your Wi-Fi router (not included) provides Internet connectivity to your HD video monitor system. It serves as a communication channel between your baby unit and mobile device, allowing you to monitor and/or control your baby unit wherever you are. For more details, see **Download app for mobile access** section in this quick start guide.

## NIGHT VISION

The baby unit has infrared LEDs that allow you to see your baby clearly at night or in a dark room. When the baby unit detects low light levels, the infrared LEDs are switched on automatically. The images from the baby unit are in black and white, and appears on the parent unit screen.

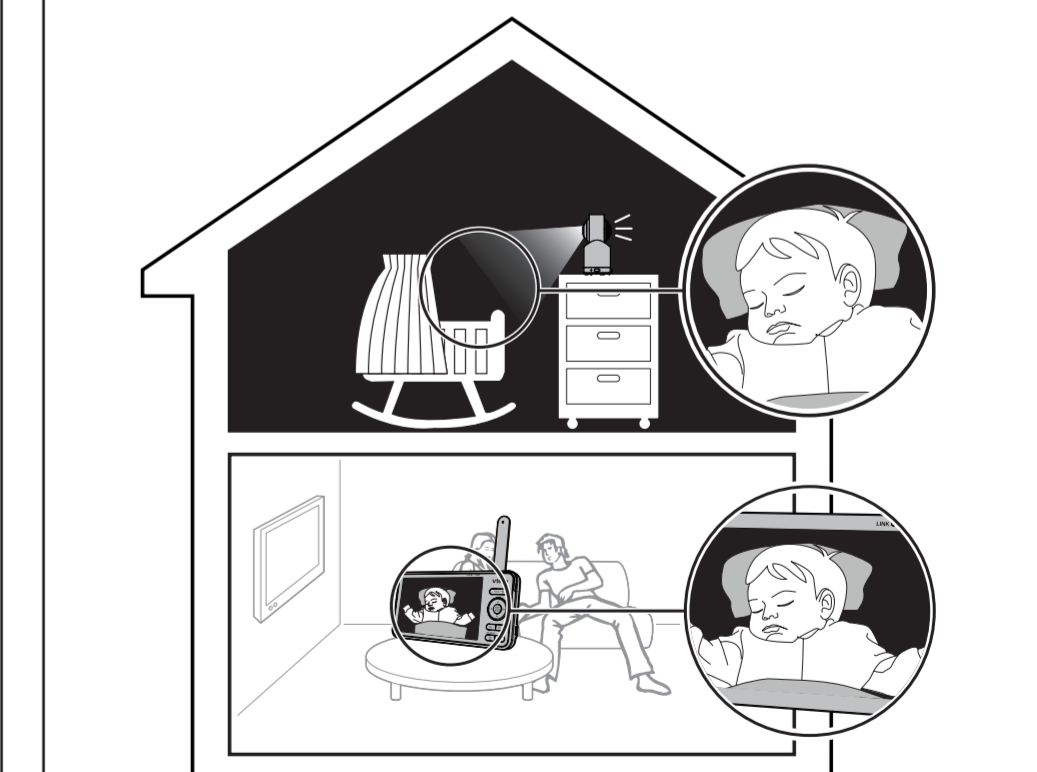

### NOTES

- A **click sound** from the baby unit is normal and occurs when your unit adapts to the environment lighting conditions.
- To achieve accurate and high quality video, your baby unit is equipped with an Infrared cut-off filter lens that optimises colour accuracy in bright, day-time environments. When the environment turns dark at night, this filter lens is withdrawn to enhance night vision quality. The brief **click sound** you hear is from the filter lens activating/deactivating as the unit switches from day to night vision (and vice versa).
- TIP**
  - Depending on the surroundings and other interfering factors, for example, lighting, objects, colours and backgrounds, the image quality may vary. Adjust the baby unit angle or place the baby unit at a higher location to prevent glare and a blurred display.

# TEST THE SOUND LEVEL AND POSITION THE BABY MONITOR

## Testing the sound level of the baby monitor

**NOTE**

- This baby monitor is intended as an aid. It is not a substitute for proper adult supervision, and should not be used as such.

**CAUTION**

- For hearing protection, make sure the parent unit is more than 3 metres away from the baby unit. If you hear any feedback noise from the parent unit, move the parent unit further until the noise stops. You can also press **VOL -** on the parent unit to lower or mute the noise.

**TIP**

- Increase the parent unit speaker volume if you cannot hear the sounds transmitted from the baby unit.

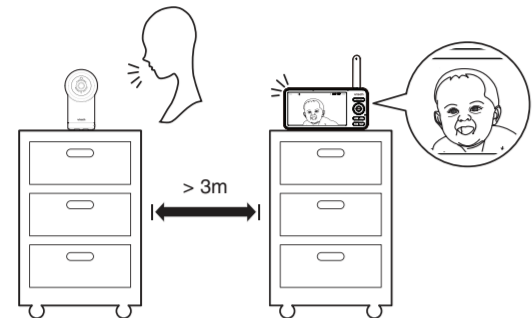

## Positioning the baby monitor

**CAUTION**

- Keep the baby unit out of reach of your baby. Never place or mount the baby unit inside the baby's cot or playpen.
- Excessive downward camera tilt may impair night vision and sound reception. If so, please adjust the tilt slightly upward.

- Place the baby unit more than 1 metre away from your baby.
- Adjust the angle of the baby unit to aim the camera at your baby.

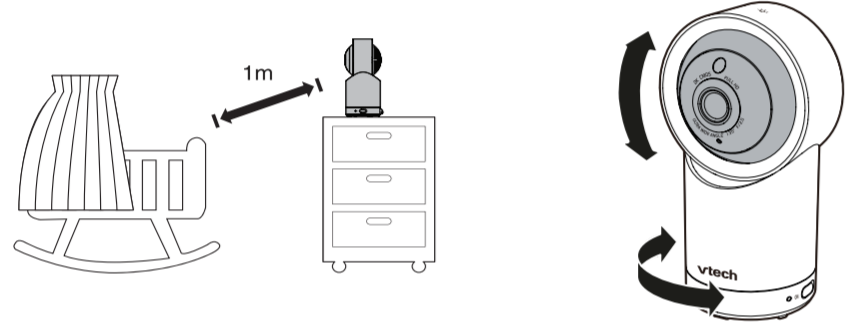

- To avoid causing feedback noise from your baby monitor:
  - Make sure your baby unit and parent unit are more than 3 metres apart; OR
  - Turn down the volume of your parent unit.

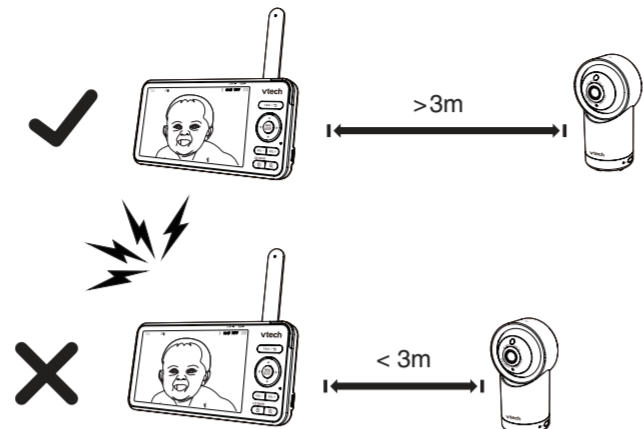

## TEST THE LOCATION FOR THE BABY UNIT

If you plan to install your baby unit in a designated location, and use your home Wi-Fi network to connect your video monitor, you need to test which of your selected monitoring areas within the house have good Wi-Fi signal strength. After you have powered on your parent unit, you can use your parent unit's **Wi-Fi signal icon(s)** to assist in checking. Once you have identified the suitable location, you can install your baby unit. Adjust the distance between your baby unit and the Wi-Fi router if needed.

**TIP**

- Surroundings and obstructing factors, such as large metallic objects, filling cabinets, long distances, electrical appliances, and internal walls, may reduce Wi-Fi signal.

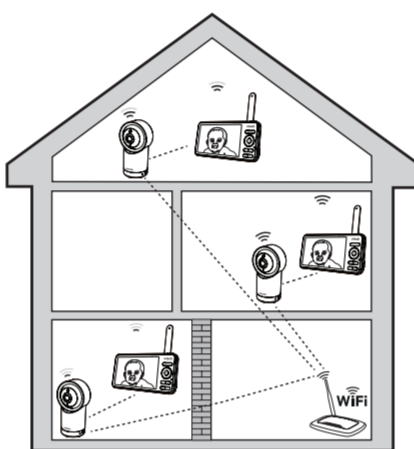

# PARENT UNIT ICONS

Main Menu	Sub-menu	Options
<b>Night light</b>	<b>On/Off</b>	Toggle the night light on or off.
	<b>Colour</b>	<ul style="list-style-type: none"> <li>Select a night light colour.</li> <li>Customised colour is available if your baby unit is paired with <b>MyVTech Baby Plus</b> app.</li> </ul>
	<b>Brightness</b>	<ul style="list-style-type: none"> <li>Adjust the night light brightness.</li> <li>Set the brightness to <b>AUTO</b> adaptive ambience.</li> </ul>
	<b>Timer</b>	<ul style="list-style-type: none"> <li>Set the timer to turn the night light off after 15, 30 or 60 minutes, or always on.</li> </ul>
<b>Melodies and soothing sounds</b>	<b>Play/Stop</b>	Toggle between play and stop.
	<b>Library</b>	<ul style="list-style-type: none"> <li>Select to play all melodies, or play one of the five melodies or five soothing sounds.</li> </ul>
	<b>Camera Volume</b>	Adjusts baby unit speaker volume.
	<b>Timer</b>	<ul style="list-style-type: none"> <li>Set the timer to stop playing after 15, 30 or 60 minutes, or play non-stop.</li> </ul>
<b>General settings</b>	<b>Connect to Mobile App</b>	<ul style="list-style-type: none"> <li>Instructions for adding baby unit to mobile app.</li> </ul>
	<b>Camera Volume</b>	Adjusts baby unit speaker volume.
	<b>Screen Brightness</b>	Adjusts parent unit screen brightness.
	<b>Screen Off Timer</b>	<ul style="list-style-type: none"> <li>Turn the screen off timer <b>OFF</b>, or set the screen to turn off after 1, 3 or 5 minutes when no sound is detected.</li> <li>Select <b>AUTO</b> to set the <b>Sound Sensitivity</b> level for the screen to auto turn on when a sound level is detected that is higher than the set level. The screen will turn off after 50 seconds of no sound detection.</li> </ul>
	<b>Temperature Format</b>	Set the temperature display format between Celsius or Fahrenheit.
	<b>Other</b>	<ul style="list-style-type: none"> <li>Time Settings (Time Display on Live View; 24 Hour Format; Time Zone) (available only after pairing the Baby Monitor with the <b>MyVTech Baby Plus</b> app), Reset Settings, Software Update.</li> </ul>
<b>Alerts Settings</b>		Adjusts the alert tone volume level.
	<b>Motion Detect</b>	<ul style="list-style-type: none"> <li>Turn the motion detection alert on/off.</li> <li>Adjust <b>Motion Sensitivity</b> level for waking the parent unit screen.</li> </ul>
	<b>Temperature</b>	<ul style="list-style-type: none"> <li>Turn the temperature alert on/off.</li> <li>Select the temperature alert maximum and minimum temperature limits.</li> </ul>
	<b>Low Battery</b>	Toggle the low battery alert on or off.
	<b>Lost Link</b>	Toggle the lost link alert on or off.
<b>Help and info</b>	<b>Help</b>	Support Information
	<b>How-to Video</b>	Support video
	<b>System Info</b>	System Information

# PROTECT YOUR PRIVACY AND ONLINE SECURITY

VTech cares about your privacy and peace of mind. That's why we've put together a list of industry-recommended best practices to help keep your wireless connection private and your devices protected when online. We recommend you carefully review and consider complying with the following tips.

- Ensure your wireless connection is secure.
  - Before installing a device, ensure your router's wireless signal is encrypted by selecting the "WPA2-PSK with AES" setting in your router's wireless security menu.
- Change default settings.
  - Change your wireless router's default wireless network name (SSID) to something unique.
  - Change default passwords to unique, strong passwords. A strong password:
    - Is at least 10 characters long.
    - Is complex.
    - Does not contain dictionary words or personal information.
    - Contains a mix of uppercase letters, lowercase letters, special characters and numbers.
- Keep your devices up to date.
  - Download security patches from manufacturers as soon as they become available. This will ensure you always have the latest security updates.
  - If the feature is available, enable automatic updates for future releases.
- Disable Universal Plug and Play (UPnP) on your router.
  - UPnP enabled on a router can limit the effectiveness of your firewall by allowing other network devices to open inbound ports without any intervention or approval from you. A virus or other malware program could use this function to compromise security for the entire network.

For more information on wireless connections and protecting your data, please review the following resources from industry experts:

- Federal Communications Commission: Wireless Connections and Bluetooth Security Tips – [www.fcc.gov/consumers/guides/how-protect-yourself-online](http://www.fcc.gov/consumers/guides/how-protect-yourself-online).
- U.S. Department of Homeland Security: Before You Connect a New Computer to the Internet – [www.us-cert.gov/ncas/tips/ST15-003](http://www.us-cert.gov/ncas/tips/ST15-003).
- Federal Trade Commission: Using IP Cameras Safely – <https://www.consumer.ftc.gov/articles/0382-using-ip-cameras-safely>.
- Wi-Fi Alliance: Discover Wi-Fi Security – <http://www.wi-fi.org/discover-wi-fi-security>.

Status icons	Status icons
<b>Direct mode</b> Parent unit and baby unit are connected to each other directly. Signal strength is indicated by the signal icon(s) on the right. The red bar(s) indicates no connection.	Night light is turned on.
<b>Wi-Fi mode</b> The signal icon(s) on the left indicate the baby unit is connected to a home Wi-Fi network. The red icon(s) indicates no connection.	Auto night light brightness is activated.
Temperature measured at baby unit.	Parent unit is muted.
Battery level indicator	Temperature measured at baby unit.
Night vision is turned on.	Low battery indicator
Motion detection alert is turned on.	Time display
Melodies and soothing sounds are playing.	Time display

# MOUNT THE BABY UNIT (OPTIONAL)

**NOTES**

Check the reception strength and baby unit camera angle before drilling any holes:

- The types of screws and wall plugs you need depend on the composition of the wall. You may need to purchase the screws and wall plugs separately to mount your baby units.

- Place the wall mount bracket on a wall and then use a pencil to mark two holes in parallel. Remove the wall mount bracket and drill two holes in the wall (5.5 mm drill bit).

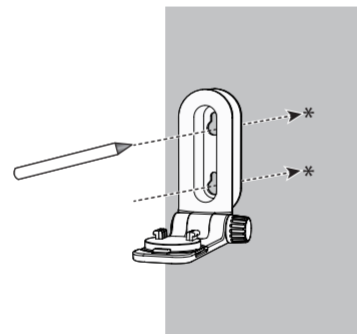

- If you drill the holes into a stud, go to step 3.
  - If you drill the holes into an object other than a stud, insert the wall plugs into the holes. Tap gently on the ends with a hammer until the wall plugs are flush with the wall.



- Align the wall mount bracket and screws with the holes in the wall as shown. Tighten the screw in the middle hole first, so that the wall mount bracket position is fixed. You can tighten the other screw in the top hole.

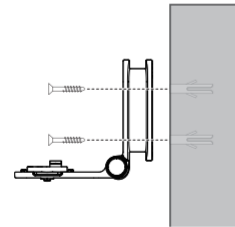

- Place the baby unit on the wall mount bracket, and then slide it forward until it locks into place. Connect the power adaptor to the baby unit and a power supply.

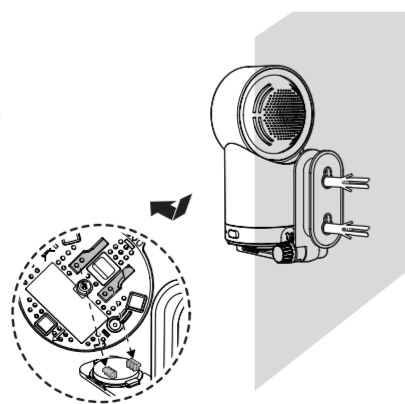

OR

- Insert the screws into the holes and tighten the screws until only 6.5 mm of the screws are exposed.

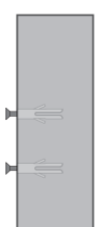

- Place the baby unit on the wall mount bracket, and then slide it forward until it locks into place. Align the holes on the wall mount bracket with the screws on the wall, and slide the wall mount bracket down until it locks into place.

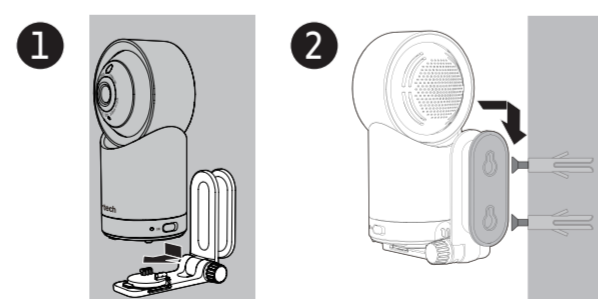

- You can maximise your baby unit viewing angle by tilting the wall mount bracket. Hold the baby unit, and then rotate the knob in an anticlockwise direction. This will loosen the joint of the wall mount bracket. Tilt your baby unit up or down to adjust to your preferred angle. Then, rotate the knob in a clockwise direction to tighten the joint and secure the angle.

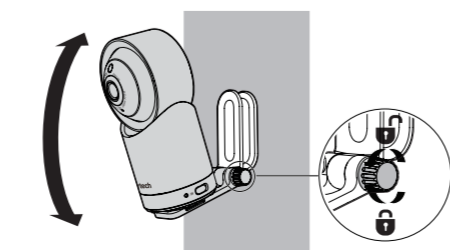

# CUSTOMER SERVICE AND PRODUCT WARRANTY

**ONE YEAR PRODUCT WARRANTY**

**PRODUCT WARRANTY**  
Thank you for choosing this quality product from VTech.

- The product detailed above is covered by a one year warranty from the date of purchase, against any defects in materials or workmanship.
- The product may be returned to the place of purchase.
- If the product covered by this warranty is damaged due to misuse, modification or unauthorised repair, or because of faulty batteries, battery discharge or incorrect electrical connections, then this warranty becomes void.
- This warranty is personal to the original purchaser and is not transferable.
- Breakages to the LCD screen are not covered by the warranty.
- Damage to the antenna is not covered by the warranty.

Email: [service-ukbm@vtechphones.eu](mailto:service-ukbm@vtechphones.eu)

VTech Electronics Europe Plc, c/o XPO Logistics, Warehouse 350, Cat & Fiddle Lane, West Hallam, DE7 6HE

THIS WARRANTY IS OFFERED AS AN EXTRA BENEFIT AND DOES NOT AFFECT CONSUMERS' STATUTORY RIGHTS.

This warranty is valid for the UK and Ireland only. For products purchased outside the UK and Ireland, please contact your local distributor or place of purchase.

## CUSTOMER SUPPORT

Find the answer to your questions and get assisted at your own pace. Scan the QR code to access the website or visit [www.vtechphones.eu](http://www.vtechphones.eu)



**IMPORTANT**  
Please retain your sales receipt as proof of the date of purchase.

## DECLARATION OF CONFORMITY

This product is intended for use within Europe and UK. This equipment complies with the essential requirements of EU Radio Equipment Directive (2014/53/EU) and the UK Radio Regulations 2017 on radio systems and telecommunication equipment.

VTech Telecommunications Ltd. hereby declares that 5" Smart High-Definition Pan & Tilt Monitor RM5766HD complies with the essential requirements and other relevant provisions of EU Radio Equipment Directive (2014/53/EU) and UK Radio Equipment Regulations 2017. The Declaration of Conformity for the RM5766HD is available from [www.vtechphones.eu](http://www.vtechphones.eu).



## DISPOSAL OF BATTERIES AND PRODUCT

- The crossed-out wheellie bin symbols on products and batteries, or on their respective packaging, indicates they must not be disposed of in domestic waste as they contain substances that can be damaging to the environment and human health.
- The chemical symbols Hg, Cd or Pb, where marked, indicate that the battery contains more than the specified value of mercury (Hg), cadmium (Cd) or lead (Pb) set out in Battery Directive (2006/66/EC).
- The solid bar indicates that the product was placed on the market after 13th August, 2005.
- Help protect the environment by disposing of your product or batteries responsibly.

# TECHNICAL SPECIFICATIONS

Frequency	Baby unit: 2402 - 2480 MHz (WiFi, FHSS, BLE) Max Transmit power is 10mW (WiFi, FHSS, BLE)
	Parent unit: 2406 - 2475 MHz Max Transmit power is 100mW
LCD	5" Colour LCD (IPS 1280 x 720 pixels)
Nominal effective range	Actual operating range may vary according to environmental conditions at the time of use.
Power requirement	Baby unit power adaptor: Output: 5V DC, 1.5A. Parent unit power adaptor: Output: 5V DC, 2A. Parent unit battery: 3.7V 5000mAh, 18.5Wh Lithium-ion battery

## GENERAL PRODUCT CARE

To keep this product working well and looking good, follow these guidelines:

- Avoid placing near heating appliances and devices that generate electrical noise (for example, motors or fluorescent lamps).
- DO NOT expose to direct sunlight or moisture.
- Avoid dropping the product or treating it roughly.
- Clean with a soft damp cloth.
- DO NOT immerse the parent unit or the baby unit in water and do not clean under running water.
- DO NOT use solvents, household cleaning sprays, or liquid cleaners.
- Make sure the parent unit and the baby unit are dry before reconnecting to the mains supply.

## STORAGE

When you are not going to use the video monitor for some time, store the parent unit, the baby unit and the adaptors in a cool, dry place.

Manufacturer: VTech Telecommunications Ltd.  
23/F., Tai Ping Industrial Centre, Block 1, 57 Ting Kok Road, Tai Po, Hong Kong.

Importer: VTech Electronics Europe Plc.  
Napier Court, Abingdon Science Park, Abingdon, Oxon, OX14 3YT.

Android™ and Google Play™ are trademarks of Google Inc.  
App Store is a trademark of Apple Inc., registered in the U.S. and other countries.  
iOS is a trademark or registered trademark of Cisco in the U.S. and other countries and is used under license.

Specifications are subject to change without notice.  
© 2024 VTech Telecommunications, Ltd.  
All rights reserved. 10/24. RM5766HD\_Gen 2\_Type-C\_QSG\_UK\_V1

