

CS2050
CS2051
CS2052
CS2053



Scan the QR code or go to www.vtechphones.eu for support information



vtech® Quick Start Guide

Important safety instructions

When using your telephone equipment, basic safety precautions should always be followed to reduce the risk of fire, electric shock and injury, including the following:

1. Read and understand all instructions.
2. Follow all warnings and instructions marked on the product.
3. Unplug this product from the wall outlet before cleaning. Do not use liquid or aerosol cleaners. Use a damp cloth for cleaning.
4. Do not use this product near water (for example, near a bath tub, kitchen sink, swimming pool).
5. Do not expose the telephone to direct sunlight or extreme cold environment. Do not put the telephone close to heating sources such as radiators, cookers, etc.
6. Do not overload wall outlets and extension cords as this can result in the risk of fire or electric shock.
7. Unplug this product from the wall outlet and refer servicing to VTech/distributor under the following conditions:
When the power supply cord or plug is damaged or frayed.
If the product does not operate normally by following the operating instructions.
If the product has been dropped and the cabinet has been damaged.
If the product exhibits a distinct change in performance.
8. Avoid using a telephone (other than a cordless type) during an electrical storm. There may be a remote risk of electric shock from lightning.
9. Do not use the telephone to report a gas leak in the vicinity of the leak.
10. Use only the supplied NiMH (Nickel Metal Hydride) batteries! The operation periods for the handsets are only applicable with the default battery capacities.
11. The use of other battery types or non-rechargeable batteries/primary cells can be dangerous. These may cause interference and/or unit damages. The manufacturer will not be held liable for damage arising from such non-compliance.
12. Do not use third party charging bays. The batteries may be damaged.
13. Please note the correct polarity while inserting the batteries.
14. Battery should not be exposed to excessive heat such as bright sunshine or fire and immersed in water.
15. ⚠️ ⚡️ Use only adaptors and battery listed below; Use only the provided external power supply: VTech Telecommunications Limited. Model: VT05EEU06045 | VT05EUK06045. Jiangxi Jian Aohai Technology Co., Ltd. Model: A318-060045W-EU1 | A318-060045W-UK1. Use only the supplied batteries: Yi Yang CORUN battery CO. LTD. Model: NI-MH AAA 400mAh 1.2V.

Disposal of Old Equipment and Batteries (WEEE)

Only for European Union and countries with recycling systems
These symbols (a, b) on the products, packaging, and/or accompanying documents mean that used electrical and electronic products and batteries must not be mixed with general household waste. For proper treatment, recovery and recycling of old products and batteries, please take them to applicable collection points in accordance with your national legislation.
By disposing of them correctly, you will help to save valuable resources and prevent any potential negative effects on human health and the environment.



For more information about collection and recycling, please contact your local municipality. Penalties may be applicable for incorrect disposal of this waste, in accordance with national legislation.

Product disposal instructions for business users

If you wish to discard electrical and electronic equipment, please contact your dealer or supplier for further information.

Information on Disposal in other countries outside the European Union

These symbols (a, b) are only valid in the European Union. If you wish to discard these items, please contact your local authorities or dealer and ask for the correct method of disposal.

Note for the battery symbol

This symbol (b) might be used in combination with a chemical symbol. In this case it complies with the requirement set by the Directive for the chemical involved.

Recycle your device (WEEE directive 2012/19/EU)

The WEEE logo appears on the product to indicate that this product must not be disposed off or dumped with your other household wastes. You are liable to dispose of all your electronic or electrical waste equipment by relocating over to the specified collection point for recycling of such hazardous waste.

Approval and conformity

This product is intended for use within Europe and the UK. This equipment complies with the essential requirements to EU's Radio Equipment Directive (2014/53/EU) and the UK's Radio Regulations 2017 on radio systems and telecommunication equipment.

VTech Telecommunication Ltd. hereby declares that this telephone CS2050/CS2051/CS2052/CS2053 is in compliance with the essential requirements and other relevant provisions of EU's Radio Equipment Directive (2014/53/EU) and the UK's Radio Equipment Regulations 2017.

The declaration of conformity may be viewed at www.vtechphones.eu.



The CE symbol confirms the conformity of the telephone and the above directive.

Importer: VTech Electronics Europe Plc.

Napier Court, Abingdon Science Park, Abingdon, Oxon, OX14 3YT.

Manufacturer: VTech Telecommunications Ltd.

23/F, Tai Ping Industrial Centre, Block 1, 57 Ting Kok Road, Tai Po, Hong Kong.

Operating condition	Power consumption
Off mode	<1 W
Network standby mode	<1 W

Customer Service and Product Warranty IMPORTANT

Please retain this guide with your sales receipt as proof of the date of purchase.

Customer Service

Please email to service-ukphone@vtechphones.eu and a service representative will be happy to help you.



PRODUCT WARRANTY

Thank you for choosing this quality product from VTech.

1. The product detailed above is covered by a one year warranty from the date of purchase, against any defects in materials or workmanship.
2. The product may be returned to the place of purchase.
3. If the product covered by this warranty is damaged due to misuse, modification or unauthorised repair, or because of faulty batteries, battery discharge or incorrect electrical connections, then this warranty becomes void.
4. This warranty is personal to the original purchaser and is not transferable.
5. Breakages to the LCD screen are not covered by the warranty.

VTech Electronics Europe Plc, c/o XPO Logistics, Warehouse 350, Cat & Fiddle Lane, West Hallam, DE7 6HE

THIS WARRANTY IS OFFERED AS AN EXTRA BENEFIT AND DOES NOT AFFECT CONSUMERS' STATUTORY RIGHTS.

This warranty is valid for the UK and Ireland only. For products purchased outside the UK and Ireland, please contact your local distributor or place of purchase.



Specifications are subject to change without notice.
©2016 VTech Telecommunications Ltd.
All rights reserved. 04/26, CS2050-2051, UK, CS5G_V3



Connect the base / charger

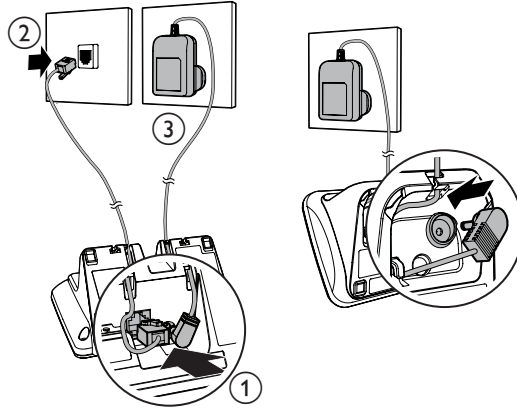

Install the battery

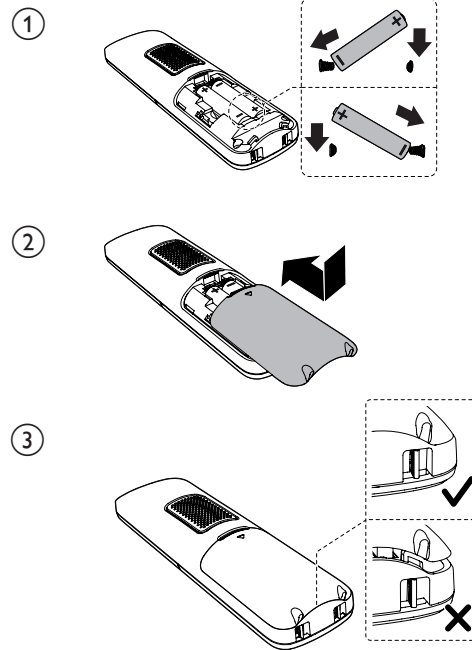

Charge the battery

Place the handset in the telephone base or charger to charge.

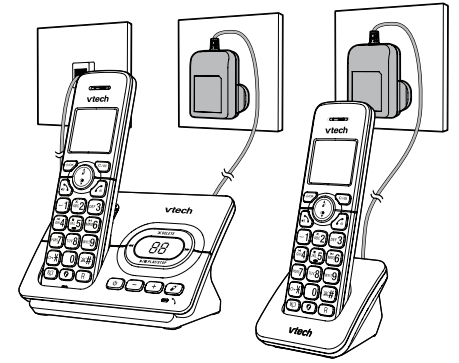

Handset	Base/ Charger	Power requirement	RF power
Handset Battery: CORUN NI-MH AAA 400mAh 1.2V	Base/ Charger VTP: VT05EEU06045 AOHAI: A318-060045W-EU1 Input 100-240V AC 50/60Hz 0.15A, Output 6VDC 0.45A 2.7W (EU plug); VTP: VT05EUK06045 AOHAI: A318-060045W-UK1 Input 100-240V AC 50/60Hz 0.15A, Output 6VDC 0.45A 2.7W (UK plug);	Power requirement ⚠️ ⚡️	>250mW
Channels	10		
Transmit frequency	1.88 GHz to 1.9GHz		
Frequency control	Crystal controlled PLL synthesizer		
Nominal effective range	Actual operating range may vary according to environment conditions at the time of use.		

- 1 x charger set for CS2051
- 2 x charger set for CS2052
- 3 x charger set for CS2053

Technical Specifications

Settings

Set language

⇨/OK → ▲/▼ → HS Settings → ⇨/OK
 → ▲/▼ → LANGUAGE → ⇨/OK
 → ▲/▼ → English | Deutsch | Français | Italiano
 | Español | Nederlands → ⇨/OK

Set date or time format

⇨/OK → ▲/▼ → HS Settings → ⇨/OK → ▲/▼
 → DATE & TIME → ⇨/OK
 1. → ▲/▼ → Date Format → ⇨/OK
 → ▲/▼ to select DD-MM-YY or MM-DD-YY →
 ⇨/OK ;
 -OR-
 2. → ▲/▼ → Time Format → ⇨/OK
 → ▲/▼ to select 12 HR / 24 HR → ⇨/OK

Set date & time

⇨/OK → ▲/▼ → HS Settings → ⇨/OK
 → ▲/▼ → DATE & TIME → ⇨/OK
 → ▲/▼ → Set Date or Set Time → ⇨/OK
 → Enter the date → ⇨/OK

Answering machine

Turn on/off the answering machine

On the handset:
 ⇨/OK → ▲/▼ → ANS. MACHINE → ⇨/OK
 → ▲/▼ → TAM ON/OFF → ⇨/OK
 → ▲/▼ to choose On/Off → ⇨/OK

-OR-

On the base:
 Press  to turn on the answering machine;
 press again to turn it off.

Record your message

⇨/OK → ▲/▼ → ANS. MACHINE → ⇨/OK
 → ▲/▼ → TAM SETTINGS → ⇨/OK
 → ▲/▼ → OGM SETTINGS → ⇨/OK → ANS
 & REC → ⇨/OK → ▲/▼ → RECORD MESS →
 ⇨/OK

• You will hear a beep tone, and then you
 can record your message.

Press ⇨/OK to end the recording.

• It will repeat your recorded message.

→ Enter the time → ⇨/OK

Ringer - external calls

⇨/OK → ▲/▼ → HS Settings → ⇨/OK
 → ▲/▼ → Ring Setup → ⇨/OK
 → ▲/▼ → Ext, Ring → ⇨/OK
 → ▲/▼ to select melody → ⇨/OK

Ringer - internal calls

⇨/OK → ▲/▼ → HS Settings → ⇨/OK
 → ▲/▼ → Ring Setup → ⇨/OK
 → ▲/▼ → Int, Ring → ⇨/OK
 → ▲/▼ to select melody → ⇨/OK



Ringer - volume

⇨/OK → ▲/▼ → HS Settings → ⇨/OK
 → ▲/▼ → Ring Setup → ⇨/OK
 → ▲/▼ → Ring Volume → ⇨/OK
 → ▲/▼ to select volume → ⇨/OK

To exit, press C/⊗ repeatedly until you return
 to the main menu.

Play/Stop, Delete, Repeat and Skip message





When there is a message on the answering
 machine, press these keys on the base to:-

Play/Stop	Delete	Repeat	Skip
			
PLAY/STOP	DELETE		

To activate the handset controls during
 message playback, press:-

⇨/OK → ▲/▼ → ANS. MACHINE → ⇨/OK
 MSG PLAYBACK → ⇨/OK

Press these handset keys to control messages.

Stop	Delete	Repeat	Skip
 5	 2	 4	 6

Tone - set key tone on/off

⇨/OK → ▲/▼ → HS Settings → ⇨/OK
 → ▲/▼ → Tone Setup → ⇨/OK → Key Tone →
 ⇨/OK → ▲/▼ to choose On or Off → ⇨/OK

Tone - set alert tones on/off

⇨/OK → ▲/▼ → HS Settings → ⇨/OK
 → ▲/▼ → Tone Setup → ⇨/OK → ▲/▼ to choose
 Battery Tone or Out of Range → ⇨/OK → ▲/▼
 to choose On or Off → ⇨/OK





Alarm - set alarm time and activation

⇨/OK → ▲/▼ → HS Settings → ⇨/OK
 → ▲/▼ → Alarm → ⇨/OK
 → ▲/▼ → On → ⇨/OK
 → Enter alarm time in 24 hr format → ⇨/OK
 → Display SNOOZE → ⇨/OK → ▲/▼ to select
 Snooze On or Off → ⇨/OK

Set the auto answer

⇨/OK → ▲/▼ → HS Settings → ⇨/OK
 → ▲/▼ → Auto Answer → ⇨/OK

Other controls/indicators on the base

Adjust base volume  Find HS  Line in use  Message number 

Nuisance and Unwanted Call Blocker

Add a call block entry

⇨/OK → ▲/▼ → Call Blocker → ⇨/OK
 → Black List → ⇨/OK
 → ⇨/OK → ADD → ⇨/OK
 → NAME → ⇨/OK and enter name
 → ⇨/OK → Number → ⇨/OK and enter phone
 number → ⇨/OK

Block unknown calls







⇨/OK → ▲/▼ → Call Blocker → ⇨/OK
 → ▲/▼ → Settings → ⇨/OK
 → ▲/▼ → Call Type → ⇨/OK
 → ▲/▼ → Unavailable → ⇨/OK

→ ▲/▼ to select On or Off → ⇨/OK

Phonebook

⇨/OK → ▲/▼ → Phonebook → ⇨/OK
 → All Contacts → ⇨/OK twice
 → Add → ⇨/OK
 → Name → ⇨/OK and enter name
 → ⇨/OK → Number → ⇨/OK and enter phone
 number → ⇨/OK → Melody 1
 → ▲/▼ to select melody → ⇨/OK

Quick access keys

Call list 	Redial list 	Phonebook 	Call Blocker 
Recall 	Mute ringer Pound or Hash key 	Keypad lock Star key 	Space 1 

Choose from the table below to block
 different types of calls:-

Block mode	Call type
<ul style="list-style-type: none"> • OFF • Block feature is off. All calls ring normally. 	<ul style="list-style-type: none"> • WITHHELD (Withheld number)
<ul style="list-style-type: none"> • BLOCK ALL • No ring for all calls. 	<ul style="list-style-type: none"> • INTERNAT'L (International number)
<ul style="list-style-type: none"> • ALLOW WLST • Ring for those numbers in the White List. 	<ul style="list-style-type: none"> • UNAVAILABLE (Unavailable number)
<ul style="list-style-type: none"> • BLOCK BLIST • Ring for all calls except numbers in the Black List. 	<ul style="list-style-type: none"> • PAYPHONE (Payphone number)