

RM5756HD

5" HD Wi-Fi Video Baby Monitor Night Light



vtech®

Quick start guide

Congratulations

on purchasing your new VTech product. Before using this HD video monitor, please read **Important safety instructions.**

WHAT DOES HD VIDEO BABY MONITOR DO?

VTech 5" HD Wi-Fi Video Baby Monitor allows you to stay close to your baby when you are on the move or away.

This monitor is Wi-Fi enabled, which uses your home wireless network to stream live video and audio through the HD baby unit and 5-inch color screen parent unit. It allows you to maintain a constant connection to your baby.

You can also monitor from your smartphone and mobile tablet.

VTech 5" HD Wi-Fi Video Baby Monitor uses **MyVTech Baby Pro** app to let you instantly see and hear what's happening with your baby from anywhere in the world.

The app can be downloaded from the App Store or the Google Play™ Store, directly from your smartphone or mobile tablet.

IMPORTANT SAFETY INSTRUCTIONS

The applied nameplate is located at the bottom of the baby unit's base.

When using your equipment, basic safety precautions should always be followed to reduce the risk of fire, electric shock and injury, including the following:

1. Follow all warnings and instructions marked on the product.
2. Adult setup is required.
3. **CAUTION:** Do not install the baby unit at a height above.
4. This product is intended as an aid. It is not a substitute for responsible and proper adult supervision and should not be used as such.
5. This product is not intended for use as a medical monitor.
6. Do not use this product near water, for example, near to a bath, sink, swimming pool or shower.
7. **CAUTION:** Use only the battery provided. There may be a risk of explosion if a wrong type of battery is used for the parent unit. The battery cannot be subjected to high or low extreme temperature and low air pressure at high altitude during use, storage transportation. Disposal of battery in fire or a hot oven, mechanically crushing or cutting the battery can result in an explosion. Leaving the battery in an extremely high temperature surrounding environment can result in an explosion or the leakage of flammable liquid of gas. Battery subjected to extremely low air pressure may result in an explosion or the leakage of flammable liquid or gas. Dispose of used battery according to the in instructions.
8. Use only the adapters included with this product. Incorrect adapter polarity or voltage can seriously damage the product.



Power adapter information:

Parent unit output: 5V DC 2A
VTech Telecommunications Ltd.
Model: VT07EEU05200
Baby Unit output: 5V DC 1A
VTech Telecommunications Ltd.
Model: VT05EEU05100



Rechargeable battery information:

3.7V 5000mAh, 18.5Wh Lithium-ion battery
Zhuhai Great Power Energy Co., Ltd.
Model: GSP806090-5Ah-3.7V-1S1P



9. The power adapter is intended to be correctly oriented in a vertical or floor mount position. The prongs are not designed to hold the plug in place if it is plugged into a ceiling, under-the-table or cabinet outlet.
10. For pluggable equipment, the socket-outlet (power adapter) should be installed near the equipment and should be easily accessible.
11. Unplug this product from the wall outlet before cleaning. Do not use liquid or aerosol cleaners. Use a damp cloth for cleaning.
12. Do not modify the power adapters or replace with other adapters, as this causes a hazardous situation.
13. Do not allow anything to rest on the power cords. Do not install this product where the cords may be walked on or crimped.
14. This product should be operated only from the type of power source indicated on the marking label. If you are not sure of the type of power supply in your home, consult your retailer or electricity supply provider.
15. Do not overload wall outlets or use an extension cord.
16. Do not place this product on an unstable table, shelf, stand or other unstable surfaces.
17. This product should not be placed in any area where proper ventilation is not provided. Slots and openings in the back or bottom of this product are provided for ventilation. To protect them from overheating, these openings must not be blocked by placing the product on a soft surface such as a bed, sofa or rug. This product should never be placed near or over a radiator or heat source.
18. Never push objects of any kind into this product through the slots because they may touch dangerous voltage points

or create a short circuit. Never spill liquid of any kind on the product.

19. To reduce the risk of electric shock, do not disassemble this product, but take it to an authorised service facility. Disassembling or removing parts of the product other than via the battery door may expose you to dangerous voltages or other risks. Incorrect reassembling can cause electric shock when the product is subsequently used.
20. You should test the sound reception every time you turn on the units or move one of the components.
21. Periodically examine all components for damage.
22. There is a very low risk of privacy loss when using certain electronic devices, such as baby monitors, cordless telephones, etc. **To protect your privacy, make sure the product has never been used before purchase, reset the baby monitor periodically by powering off and then powering on the units, and power off the baby monitor if you are not intending to use it for some time.**
23. Children should be supervised to ensure that they do not play with the product.
24. The small parts of this monitor can be swallowed by babies or small children. Keep these parts out of reach of children.
25. The product is not intended for use by persons (including children) with reduced physical, sensory or mental capabilities, or lack of experience and knowledge, unless they have been given supervision or instruction concerning use of the appliance by a person responsible for their safety.

SAVE THESE INSTRUCTIONS

Cautions

- Use and store the product at a temperature between 0°C and 40°C.
- Mishandling batteries can cause burn, fire or explosion hazards.
- Batteries should not be exposed to excessive heat such as bright sunshine or fire.
- Do not expose the product to extreme cold, heat or direct sunlight. Do not put the product close to a heating source.
-  **Warning—Strangulation Hazard—Children have STRANGLED in cords. Keep this cord out of the reach of children (more than 0.9m away). Do not remove warning label on the adapter cord.** 
- Never place the baby unit inside the baby's cot or playpen. Never cover the baby unit or parent unit with anything such as a towel or a blanket.
- Other electronic products may cause interference with your camera unit. Try installing your camera unit as far away from these electronic devices as possible: wireless routers, radios, cellular telephones, intercoms, room monitors, televisions, personal computers, kitchen appliances and cordless telephones.

Precautions for users of implanted cardiac pacemakers

Cardiac pacemakers (applies only to digital cordless devices): Wireless Technology Research, LLC (WTR), an independent research entity, led a multidisciplinary evaluation of the interference between portable wireless devices and implanted cardiac pacemakers. Supported by the U.S. Food and Drug Administration, WTR recommends to physicians that:

Pacemaker patients

- Should keep wireless devices at least six inches from the pacemaker.
 - Should NOT place wireless devices directly over the pacemaker, such as in a breast pocket, when it is turned ON.
- WTR's evaluation did not identify any risk to bystanders with pacemakers from other persons using wireless devices.

Electromagnetic fields (EMF)

This VTech product complies with all standards regarding electromagnetic fields (EMF). If handled properly and according to the instructions in this user's manual, the product is safe to be used based on scientific evidence available today.



WHAT'S IN THE BOX

Your HD video monitor package contains the following items. Save your sales receipt and original packaging in the event warranty service is necessary.

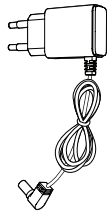
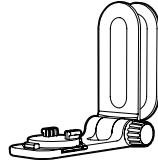
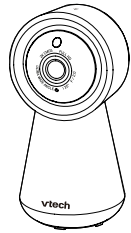
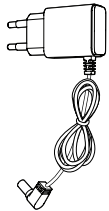
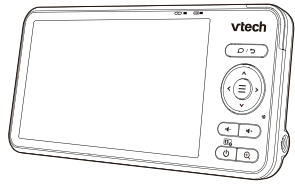

REQUIREMENTS

For mobile access:

MyVTech Baby Pro mobile app

| | |
|---------------------|---|
| Network | Wi-Fi |
| Wi-Fi router | 2.4GHz 802.11 b/g/n |
| Internet connection | 1.5 Mbps @ 720p or 2.5 Mbps @1080p upload bandwidth per baby unit |



OVERVIEW

Baby unit overview

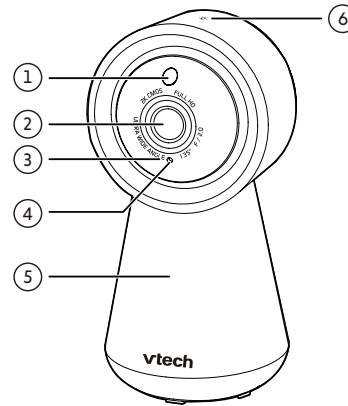

- 1 **Light sensor**
- 2 **Camera lens**
- 3 **Infrared LEDs**
 - Allow you to see clearly in a dark environment.
- 4 **Microphone**
- 5 **Night Light**
- 6 **🌙 Night Light Control Key**
 - Go to **Night Light** section to learn more.

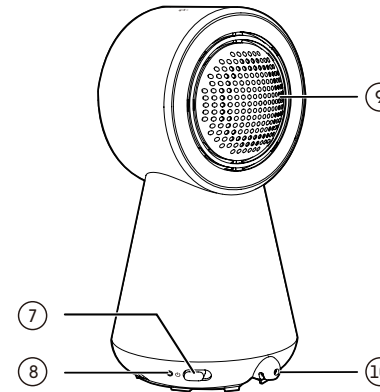

- 7 **🔌 On/Off switch**
 - Power it on or off.
- 8 **LED indicator**
 - Steadily on, then off, when the baby unit is connected to the parent unit.
 - Flashes when the baby unit is connecting with the parent unit, or the link to the parent unit has lost.
- 9 **Speaker**
- 10 **Temperature sensor**

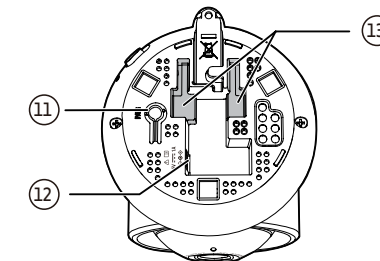

- 11 **PAIR**
 - The parent unit and baby unit provided are already paired.
 - Reset the baby unit to factory default.
 1. Press and hold **PAIR** key until you hear a beep sound.
 2. Release the **PAIR** key, and then press the **PAIR** key again five times until you hear another beep sound.
 3. The baby unit will sound another beep when the reset completes. Then, the baby unit will reboot.
- 12 **Power jack**
- 13 **Wall mount slots**

Parent unit overview

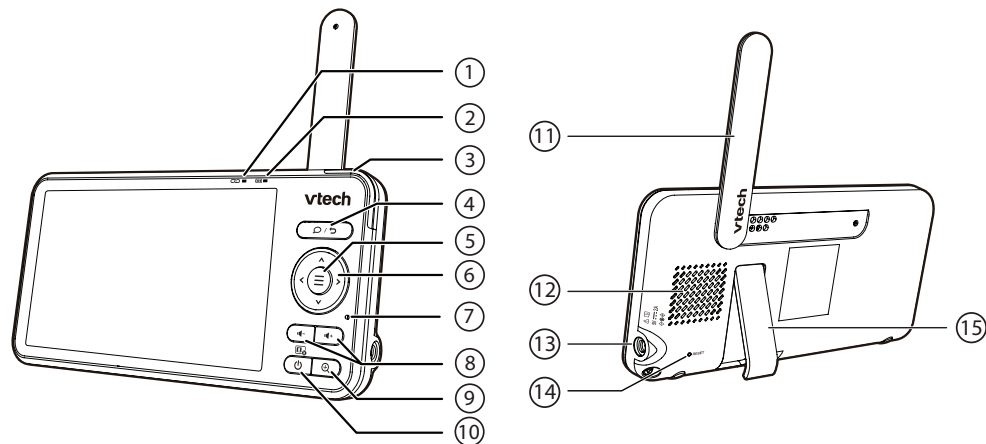

1 LINK LED light

- On when the parent unit is linked to the baby unit.
- Flashes when the link to the baby unit is lost.

2 LED light

- On when the parent unit is connected to AC power, and the battery is charging.
- Flashes when the parent unit battery is low and needs to be charged.

3 3-level sound indicator light

- Green: low sound level is detected by the baby unit.
- Green and amber: moderate sound level is detected by the baby unit.
- Green, amber and red: high sound level is detected by the baby unit.

4 D / S

- Press and hold to talk to the baby unit.
- While in a sub-menu, press to exit.

5 Menu/Select

- Press to enter the main menu.
- While in a menu, press to choose an item, or save a setting.

6 Arrow keys

- Press to navigate left, right, up and down within the main and sub-menus.
- While viewing zoomed image, press to move the zoomed image leftward, upward, rightward or downward.

7 Microphone

8 - / +

- Increase or decrease parent unit volume.

9 Zoom

- Press to zoom in/out.
- While in a sub-menu, press to view the help menu.

10 Power | LCD On/Off

11 Antenna

12 Speaker

13 Power jack

14 RESET

- Force reboot the parent unit.

15 Stand



CONNECT, CHARGE AND POWER ON THE BABY MONITOR

Connect the baby monitor

NOTES

- The rechargeable battery in the parent unit is built-in.
- Use only the power adapters supplied with this product.
- Make sure the parent unit and the baby unit are not connected to an electronically controlled electric power outlet.
- Connect the power adapters in a vertical or floor mount position only. The adapter prongs are not designed to hold the weight of the parent unit and the baby unit, so do not connect them to any ceiling, under-the-table, or cabinet outlets. Otherwise, the adapters may not properly connect to the outlets.
- Make sure the parent unit, the baby unit, and the power adapter cords are out of reach of children.

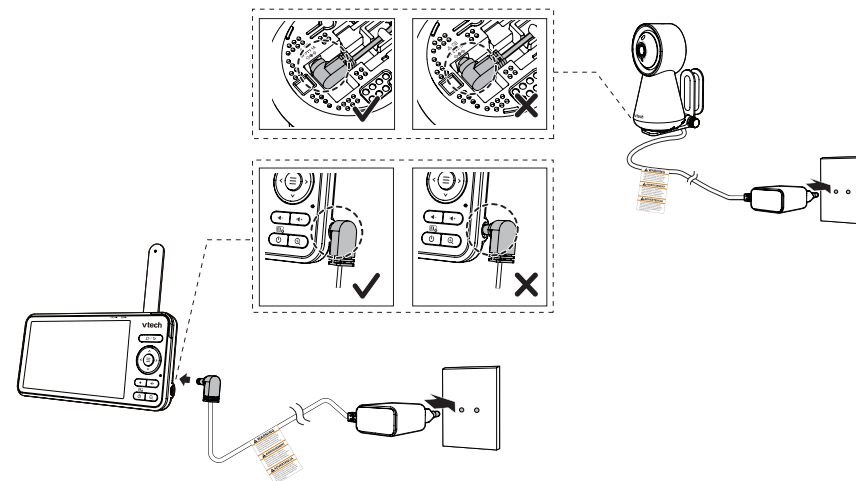

Slide the power switch to power on your baby unit.

NOTES

- After powering up, the baby unit status LED will turn on and then turn off after a short time.



NOTE:

Camera lens and surface may get warm during normal operation.

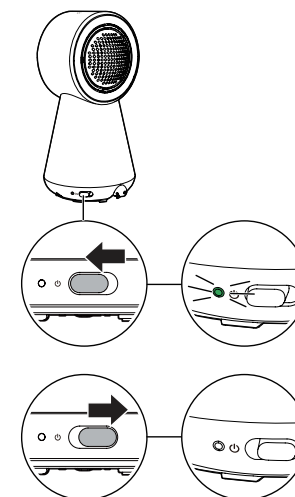

Charge the parent unit battery before use

The parent unit runs on rechargeable battery or AC power. To continuously monitor your baby, keep the parent unit connected to AC power.





NOTES

- Before using the baby monitor for the first time, charge the parent unit battery for 12 hours. When the parent unit battery is fully charged, the battery icon segments are solid .
- The standby time varies depending on your actual use.

The parent unit turns on automatically after connecting to the power socket, and the welcome screen appears. You can press  **Power** to turn the parent unit on or press and hold to turn it off.



The battery icon indicates the battery status (see the following table).

| BATTERY INDICATORS | BATTERY STATUS | ACTION |
|---|---|--|
|  and  are displayed on the parent unit screen, with the  LED light flashes. | The battery has very little charge and may be used for only a short time. | Charge without interruption (about 30 minutes). |
| The battery icon segments are solid  . | The battery is fully charged. | To keep the battery charged, connect it to AC power when in use. |

Raise the parent unit antenna for better reception

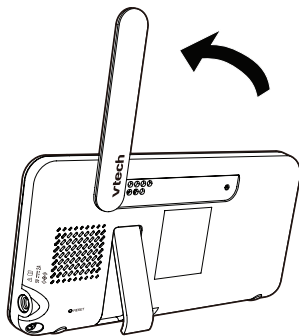

TEST THE SOUND LEVEL AND POSITION THE BABY MONITOR

Testing the sound level of the baby monitor

NOTE

- This baby monitor is intended as an aid. It is not a substitute for proper adult supervision, and should not be used as such.

CAUTION

- For hearing protection, make sure the parent unit is more than 1 metre away from the baby unit. If you hear any feedback noise from the parent unit, move the parent unit further until the noise stops. You can also press  on the parent unit to lower or mute the noise.



TIP

- Increase the parent unit speaker volume if you cannot hear the sounds transmitted from the baby unit.

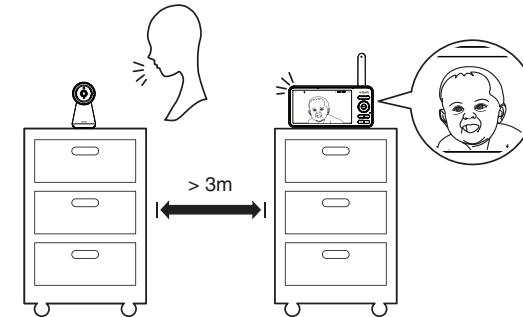

Positioning the baby monitor

CAUTION

- Keep the baby unit out of the reach of your baby. Never place or mount the baby unit inside the baby's cot or playpen.

1. Place the baby unit more than 1 metre away from your baby.

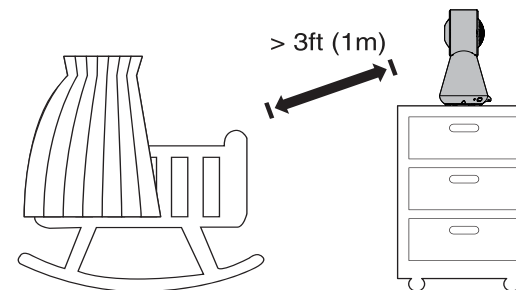

2. To avoid causing feedback noise from your baby monitor:

- Make sure your baby unit and parent unit are more than 1 metre apart; OR
- Turn down the volume of your parent unit.

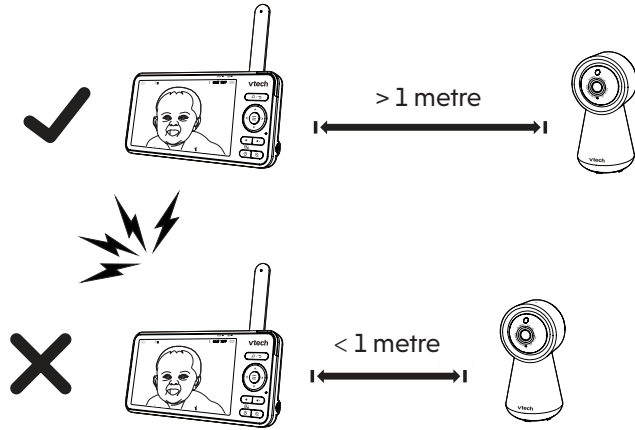

PARENT UNIT ICONS

Status icons

Direct mode
The parent unit and baby unit connect to each other directly. Red bars indicate no connection.

Router mode
The parent unit and baby unit connect via the home Wi-Fi network. The red icon(s) on the baby unit or parent unit, indicates no connection between the respective unit(s) and the router.

Night vision is turned on.

Motion detection alert is turned on.

Status icons

Melodies and soothing sounds are playing.

Night light is turned on.

Auto night light brightness is activated.

Temperature alert is turned on.

Parent unit is muted.

Temperature

Battery level indicator

Low battery indicator

PARENT UNIT ICONS

| Main Menu | Sub-menu | Options |
|--------------------|----------|---|
| Night light | | |
| | | On/Off <ul style="list-style-type: none"> • Turn on or turn off night light. |
| | | Color <ul style="list-style-type: none"> • Select a night light color. |
| | | Brightness <ul style="list-style-type: none"> • Adjust night light brightness. • Set the brightness to Auto adaptive ambience. |
| | | Timer <ul style="list-style-type: none"> • Set the timer to turn off night light after 15, 30 or 60 minutes, or remain on always. |

Melodies and soothing sounds

Play or Stop the lullaby.

Library
• Select to play all melodies, or play one of the five melodies or five soothing sounds.

Camera Volume
• Adjust the play volume level.

Timer
• Set the timer to stop playing after 15, 30 or 60 minutes, or play non-stop.

General settings

Camera Connection
• Connect to home Wi-Fi network.
• Connect mobile phone.

Camera Volume
• Adjust Baby Unit speaker volume.

Screen Brightness
• Adjust Parent Unit screen brightness.

| Main Menu | Sub-menu | Options |
|-----------|----------|--|
| | | Screenoff Timer <ul style="list-style-type: none"> • The parent unit screen will turn off after the selected time to save energy. You can still hear your baby while the screen is turned off. |
| | | Temperature Format <ul style="list-style-type: none"> • Change temperature display format. |
| | | Other <ul style="list-style-type: none"> • Language, Reset settings, Software update. |

Alerts Settings

• Adjust alerts volume level.

Motion Detect
• Turn on/off motion detection alert.
• Adjust **Motion Sensitivity Level** to activate parent unit screen.

Temperature
• Turn on/off temperature detection alert.
• Select maximum and minimum temperature for alert range.

Low battery
• Turn on/off low battery alert.

Lost link
• Turn on/off lost link alert.

Help and info

Help
• Support Information

How-to Video
• Support video

System Info
• System Information



BASIC OPERATION

After powering up your baby monitor, the parent unit streams live video in direct mode. We recommend you follow the instructions on-screen to set up home Wi-Fi network with your monitor for functionality enhancements and mobile access. See **Auto software and firmware update** and **Download app for mobile access** in this Quick Start Guide.

Use the menu

Press on the parent unit to enter the main menu, choose a menu item, or save a setting. You can use the parent unit menu for advanced settings or operations, such as to play or stop the baby unit lullaby, or adjust the baby unit sound sensitivity.

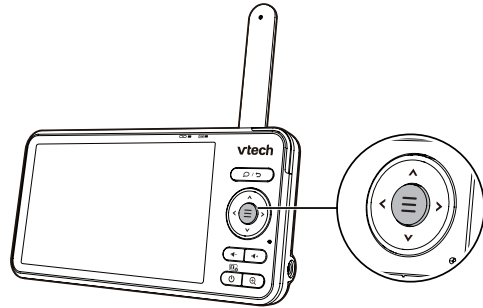

While in the menu:

- Press to scroll through the menu options.
- Press to select an item.
- Press / to return to the live video.
- Press to go to the **Help & info** page.

Adjust speaker volume

Press / to adjust the parent unit speaker volume level received from the baby unit.

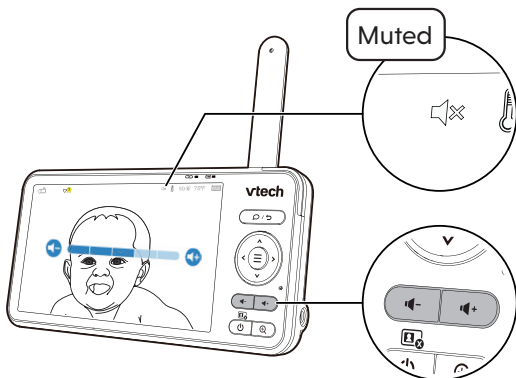

Zoom

Press to zoom in or out in a fixed zoom sequence. indicates the image is magnified 3 times.

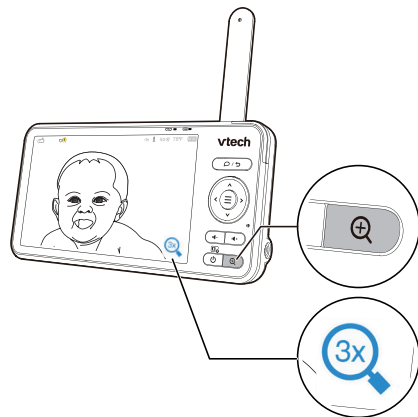

Talk to your baby via the Baby Unit

1. Press and hold the key.
2. When the icon displays on screen, speak to your parent unit. Your voice is transmitted to the baby unit.
3. When finished talking, release the key to hear your baby again.

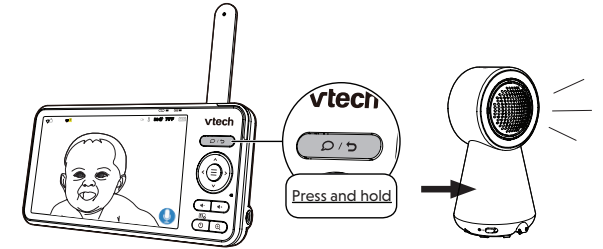

Turn on/off the Parent Unit screen

You can turn on or turn off the parent unit screen without powering off the unit. You will still hear sounds from the baby unit.

- Press on the parent unit to turn off the screen.
- Press any key on the parent unit to turn the screen on again.



☀ TIP

To restore to the default settings or reset the Wi-Fi connection, you can reset the parent unit by pressing the **RESET** key at the back of the unit.



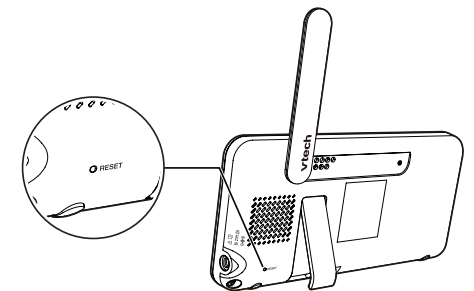



Insert a pin into the **RESET** hole on the back of the parent unit, and then gently press the button inside.





NIGHT LIGHT

You can control the night light remotely on the parent unit or directly on the baby unit.

On the Parent Unit:

1. Press .
2. Press  or  to scroll to  **Night Light** menu.
3. Press  or  to choose below options:

  Turn on/off night light

 Change night light colour

 Adjust night light brightness

 Set night light timer

On the Baby Unit:

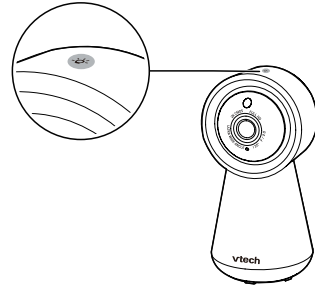

Night Light Control Key

Single Tap: Turn on/off

Tap and hold (with the light turned on): Adjust night light brightness.



DOWNLOAD APP FOR MOBILE ACCESS

1 App installation

a) From parent unit

NOTE

- Before installing the app, please connect your baby monitor to your Wi-Fi network.
Press  on the parent unit, go to  > .

1. Press  when the parent unit is idle.

2. Go to  >  > **Connect Mobile Phone**.

3. Scan the QR code in the parent unit to download the app into your mobile device.

b) From app store

1. Browse the App Store  or the Google Play store .

2. Search for the mobile app with the keyword "myvtech baby pro".

3. Download and install the **MyVTech Baby Pro** mobile app to your mobile device.

OR

Scan the QR code on the right to get the app.

NOTE

- Make sure your mobile device meets the minimum requirement for the mobile app.

Minimum requirement

The mobile app is compatible with:

- Android™ 6.0 or later; and
- iOS 12 or later.



2 Set up user account

In your mobile device:

1. Tap  to run the mobile app, and then create a user account.
2. We recommend that you use common webmail services, such as Google Gmail for registration of your user account. Check your email (and Spam folder), and activate your new camera account via the email link, then sign in to your account.

3 Add camera

Follow the instructions in the mobile app to pair the camera.





HOW THE SYSTEM WORKS

TIP For better security and more stable connectivity, this baby monitor requires connecting to a 2.4GHz home Wi-Fi network and operating in Router mode connection.

Direct mode

Your baby monitor parent unit and baby unit connect to each other in **Direct mode** by default, which allows you to immediately stream video out of the box.

It is NOT recommended to continue using Direct Mode connection after initial installation.

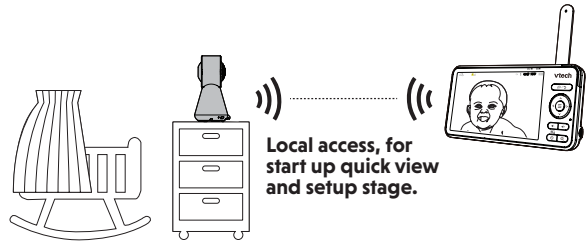

TIP

You may experience reduced signal strength if your parent unit and baby unit are far apart, or there are obstructing factors, such as internal walls, between them. You have to set up **Router mode** to connect the units via your home Wi-Fi network to improve the connection between your parent unit and baby unit.

Router mode

You are required to set up your monitor in **Router mode** to enjoy live video streaming via your parent unit with an enhanced connection.

Router mode is the recommended mode for stable connectivity.

Router mode uses your 2.4GHz home Wi-Fi network to connect your video monitor. It supports live video streaming through the parent unit and smartphone app.

If you want to stream live video remotely with your mobile device, download and install the **MyVTech Baby Pro** mobile app. With the mobile app, your Wi-Fi router (not included) provides Internet connectivity to your HD video monitor system. It serves as a communicating channel between your baby unit and mobile device, allowing you to monitor and/or control your baby unit wherever you are. For more details, see **Download app for mobile access** section in this quick start guide.

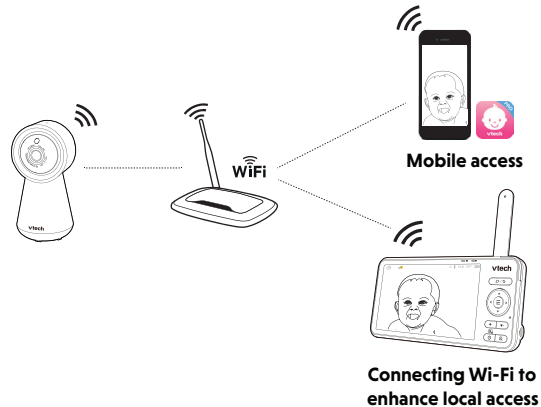

NOTE

- When both parent unit and app are viewing the camera simultaneously, the video quality will be optimised to deliver the best possible viewing result.



PROTECT YOUR PRIVACY AND ONLINE SECURITY

VTech cares about your privacy and peace of mind. That's why we've put together a list of industry-recommended best practices to help keep your wireless connection private and your devices protected when online. We recommend you carefully review and consider complying with the following tips.

Ensure your wireless connection is secure.

- Before installing a device, ensure your router's wireless signal is encrypted by selecting the "WPA2-PSK with AES" setting in your router's wireless security menu.

Change default settings.

- Change your wireless router's default wireless network name (SSID) to something unique.
- Change default passwords to unique, strong passwords. A strong password:
 - Is at least 10 characters long.
 - Is complex.
 - Does not contain dictionary words or personal information.
 - Contains a mix of uppercase letters, lowercase letters, special characters and numbers.

Keep your devices up to date.

- Download security patches from manufacturers as soon as they become available. This will ensure you always have the latest security updates.
- If the feature is available, enable automatic updates for future releases.

Disable Universal Plug and Play (UPnP) on your router.

- UPnP enabled on a router can limit the effectiveness of your firewall by allowing other network devices to open inbound ports without any intervention or approval from you. A virus or other malware program could use this function to compromise security for the entire network.



TEST THE LOCATION FOR THE BABY UNIT

If you plan to install your baby unit in a designated location, and use your home Wi-Fi network to connect your video monitor, you need to test which of your selected monitoring areas within the house have good Wi-Fi signal strength. After you have powered on your Parent Unit, you can use your Parent Unit Wi-Fi signal strength indicator to assist in checking. Once you have identified the suitable location, you can install your baby unit. Adjust the distance between your baby unit and the Wi-Fi router if needed.

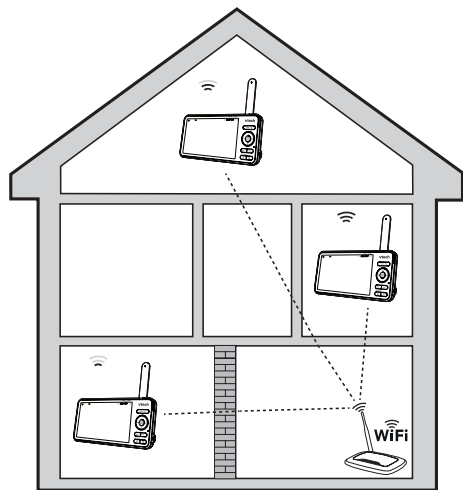

TIP

- Depending on surroundings and obstructing factors, such as the effect distance and internal walls have on signal strength, you may experience reduced Wi-Fi signal. To improve the Wi-Fi signal strength, adjust the distance or direction of your Parent Unit. Check with your Parent Unit again.



AUTO SOFTWARE AND FIRMWARE UPDATE

To ensure that your HD video monitor is always at its best performance, the parent unit will prompt a message and ask you to update its software and the baby unit's firmware when there are new versions available. Select "Now" to reboot the system, or switch off and on the parent unit later to reboot the system into the latest software.

- To check if your device is running on the latest software, or to update your device software, go to:



Connect your HD video monitor with home Wi-Fi network

- You must connect your video monitor to your secured home Wi-Fi network in order to receive the latest software and firmware updates. To set the Wi-Fi up, go to:



NOTE

- Make sure the baby unit is on when you set up the Wi-Fi network.



MOUNT THE BABY UNIT (OPTIONAL)

NOTES

- Check for reception strength and camera angle of the baby unit before drilling the holes.
- The types of screws and anchors you need depend on the composition of the wall. You may need to purchase the screws and anchors separately to mount your baby units.

- Place the wall mount bracket on a wall and then use a pencil to mark two holes in parallel. Remove the wall mount bracket and drill two holes in the wall (5.5mm drill bit).

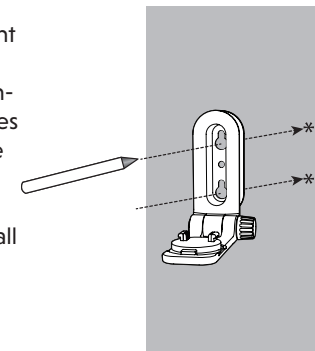

- If you drill the holes into a stud, go to step 3.
- If you drill the holes into an object other than a stud, insert the wall anchors into the holes. Tap gently on the ends with a hammer until the wall anchors are flush with the wall.

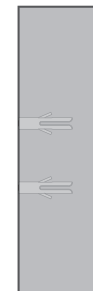

- Align the wall mount bracket and screws with the holes in the wall as shown. Tighten the screw in the middle hole first, so that the wall mount bracket position is fixed. You can tighten the other screw in the top hole.

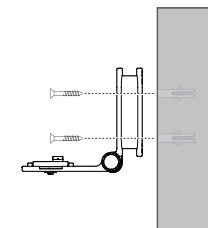

- Place the baby unit on the wall mount bracket, and then slide it forward until it locks into place. Connect the power adapter to the baby unit and a power supply.

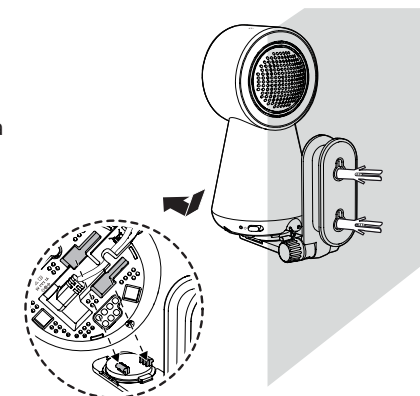

Below are the questions most frequently asked about the baby monitor.

3. Insert the screws into the holes and tighten the screws until only 6.5mm of the screws are exposed.

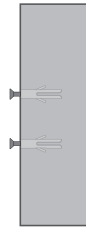

OR

4. Place the baby unit on the wall mount bracket, and then slide it forward until it locks into place. Align the holes on the wall mount bracket with the screws on the wall, and slide the wall mount bracket down until it locks into place.

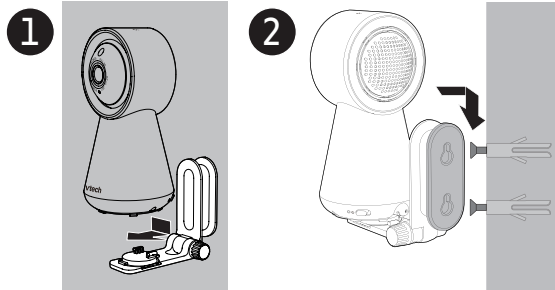

5. You can maximize your baby unit's viewing angles by tilting the wall mount bracket. Hold the baby unit, and then rotate the knob in anticlockwise direction. This will loosen the joint of the wall mount bracket. Tilt your baby unit up or down to adjust to your preferred angle. Then, rotate the knob in clockwise direction to tighten the joint and secure the angle.

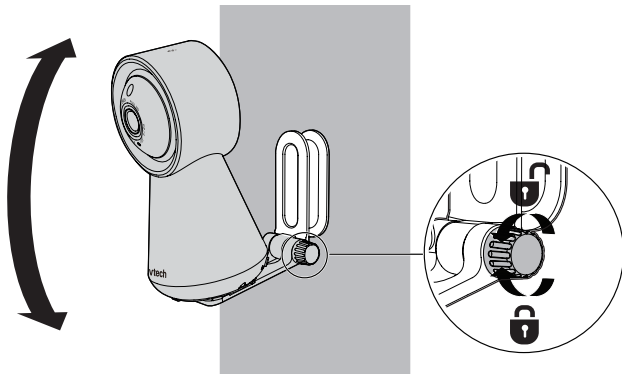

Why does the baby monitor not respond normally?

Try the following (in the order listed) for common cure:

1. Disconnect the power to the baby unit and the parent unit.
2. Wait a few seconds before connecting power back to the baby unit and the parent unit.
3. Turn on the baby unit and the parent unit.
4. Wait for the parent unit to synchronise with the baby unit. Allow up to one minute for this to take place.

Why doesn't the baby unit and parent unit power-on light illuminate when the units are switched on?

Perhaps the parent unit is not connected to the power. Insert the adaptor plug into the parent unit and insert the adaptor in a wall socket. Then, press **Power** to switch on the parent unit and to establish connection with the baby unit.

Perhaps the baby unit is not connected to the power. Insert the adaptor plug into the baby unit and insert the adaptor in a wall socket. Then, slide the **ON/OFF** switch to **ON** to switch on the baby unit to establish connection with the parent unit.

Why doesn't my parent unit charge while connected to AC power?

Make sure the power is not controlled by a electronic wall switch.

The battery may be degraded through extended use or defective. See **Warranty** for repair/replacement.

Why is my screen in black and white?

The screen is in black and white during night-time or in a dark room when the night vision feature is activated. This is normal.

Why do I get glare or blurry display on my screen when viewing my baby at night?

During night-time or in a dark room, the surroundings and other interfering factors, like lighting, objects, colours and backgrounds may affect the image quality on your parent unit screen. Adjust the baby unit angle or place the baby unit at a higher level to prevent glare and a blurry display.

Why does the baby monitor produce a feedback noise?

The parent unit and baby unit may be too close to each other.

- Move the parent unit away from the baby unit until the noise stops; OR
- Turn down the volume of your parent unit.

Why does the parent unit beep?

The baby unit(s) may be out of range. Move the parent unit closer to the baby unit (but not less than 1m).

The parent unit may not have enough charge for the parent unit to perform normally. Charge the battery in the parent unit until the battery icon becomes solid .

The temperature of your baby's room may be too high or too low.

Why does the parent unit react too quickly to other sounds?

The baby unit also picks up other sounds than those of your baby. Adjust the VOX sensitivity level to a lower level or lower the parent unit speaker volume.

Why don't I hear a sound/Why can't I hear my baby cry?

The parent unit speaker volume may be too low. See **Adjust parent unit speaker volume** to increase the volume.

Why can't I establish a connection? Why is the connection lost every now and then? Why are there sound interruptions?

The baby unit may be out of range. Move the parent unit closer to the baby unit (but not less than 1m).

Other electronic products and wireless products may cause interference with your baby monitor. Try installing your baby monitor as far away from these devices as possible.

GENERAL PRODUCT CARE

To keep this product working well and looking good, follow these guidelines:

- Avoid placing it near heating appliances and devices that generate electrical noise (for example, motors or fluorescent lamps).
- DO NOT expose it to direct sunlight or moisture.
- Avoid dropping the product or treating it roughly.
- Clean with a soft damp cloth.
- DO NOT immerse the parent unit and the baby unit in water and do not clean them under running water.
- DO NOT use cleaning spray or liquid cleaners.
- Make sure the baby unit and parent unit are dry before you connect them to the mains again.

STORAGE

When you are not going to use the baby monitor for some time, store the parent unit, the baby unit and the adaptors in a cool, dry place.

ADULT SUPERVISION

- This baby monitor should be used as an aid and proper adult supervision is required.
- Do not place the baby unit inside the crib or playpen.
- As for child's safety, touch or play with the baby monitor and all the accessories are not allowed. THIS IS NOT A TOY.

TECHNICAL SPECIFICATIONS

| | |
|-------------------------|---|
| Transmit frequency | Baby unit: 2412 - 2472 MHz Parent unit: 2412 - 2472 MHz |
| Channels | 13 |
| LCD | 5" Color LCD (IPS 1280x720 pixels) |
| Nominal effective range | Actual operating range may vary according to environmental conditions at the time of use. |
| Power requirement | Baby unit power adapter: Output: 5V DC, 1A. Parent unit power adapter: Output: 5V DC, 2A. Parent unit battery: 3.7V 5000mAh, 18.5Wh Lithium-ion battery |

Credits:
The *Background Noise* sound file was created by Caroline Ford, and is used under the Creative Commons license.
The *Stream Noise* sound file was created by Caroline Ford, and is used under the Creative Commons license.
The *Crickets At Night* sound file was created by Mike Koenig, and is used under the Creative Commons license.
The *Heart Beat* sound file was created by Zarabadeu, and is used under the Creative Commons license.

Android™ and Google Play™ are trademarks of Google Inc.
App Store is a trademark of Apple Inc., registered in the U.S. and other countries.
iOS is a trademark or registered trademark of Cisco in the U.S. and other countries and is used under license.

Importer: Snom Technology GmbH.
Aroser Allee 66, 13407, Berlin.

Manufacturer: VTech Telecommunications Ltd.
23/F., Tai Ping Industrial Centre, Block 1, 57 Ting kok Road, Tai Po, Hong Kong.

PRODUCT WARRANTY



CUSTOMER SERVICE AND WARRANTY

IMPORTANT
Please retain the receipt as proof of purchase.

Customer service
You are the owner of a quality product from VTech®, manufactured with care and under strict quality controls.

The warranty does not cover the following:

- Damage to the product due to improper use.
- Damage caused by failure to observe the operating instructions.
- Unauthorised repairs or modifications to the product.
- Faulty batteries or damage caused by battery leakage.
- Damage caused by defective or ineffective packaging used in transit or damage caused during transportation.
- Damage to the LCD display.

If you have any questions, please contact our Customer Service:

www.vtechphones.eu

DECLARATION OF CONFORMITY

This product is intended for use within Europe.

This equipment complies with the essential requirements for the Radio Equipment and Telecommunications Terminal Equipment Directive 2014/53/EU.

VTech Telecommunications Ltd. hereby declares that this Video Baby Monitor RM5756HD is in compliance with the essential requirements and other relevant provisions of Directive 2014/53/EU.

The Declaration of Conformity for the RM5756HD is available from www.vtech.com/rtte-directive.



DISPOSAL OF BATTERIES AND PRODUCT



The crossed-out wheellie bin symbols on products and batteries, or on their respective packaging, indicates they must not be disposed of in domestic waste as they contain substances that can be damaging to the environment and human health.



The chemical symbols Hg, Cd or Pb, where marked, indicate that the battery contains more than the specified value of mercury (Hg), cadmium (Cd) or lead (Pb) set out in Battery Directive (2006/66/EC). The solid bar indicates that the product was placed on the market after 13th August, 2005.



Help protect the environment by disposing of your product or batteries responsibly.



Specifications are subject to change without notice.
© 2023 VTech Telecommunications Ltd.
All rights reserved. 06/23. RM5756HD_SNOM_EN_QSG_V1

